

FT560 VAN VEEN GRAB

The Feritech FT560 Van Veen Grab is the most universal of the grab samplers, ideal for taking samples in shallow to medium water depths and for biological, hydrological and environmental studies. Available in 4 different sizes, we have a Van Veen to suit all projects, big or small.

The lead-weighted jaws close positively, capturing the sample for secure recovery to the surface. The weights also enable reliable operation in strong currents, and extra weights can be added for hard seabed conditions.

PRODUCT HIGHLIGHTS

- Comes in 4 sizes: 0.025m², 0.1m², 0.2m² and 0.25m²
- Easy to handle and can be used from any size of vessel
- Inspection lids for easy sampling
- Optional lead weights for extra penetration
- Configurable weights for strong currents and hard seabeds
- Marine AISI 316 grade stainless steel construction
- Works at any depth
- Virtually maintenance free
- Available from stock

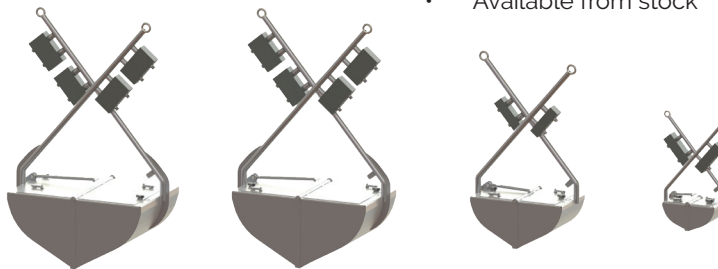

Innovative Engineering

All our products are designed, manufactured and tested to the highest standards by our UK team. Many are available immediately from stock, providing unparalleled access to spares and consumables.

Bespoke Solutions

All our systems work straight out of the box and can be mobilised within hours. As with all Feritech products, we can tailor it to your exact needs. Please contact us to discuss your requirements.

Global Warranty & Support

All our equipment comes with a global support and warranty package. With global delivery and exceptional reliability, get the best technical support wherever and whenever you might need it.

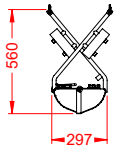
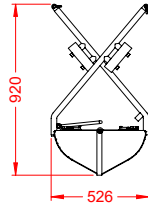
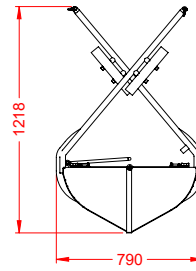
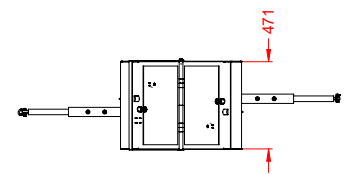
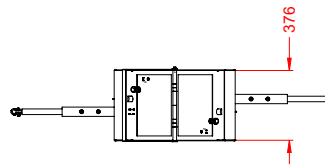
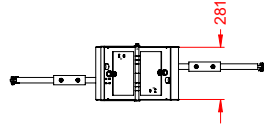
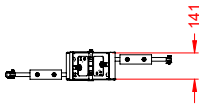
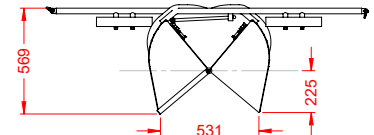
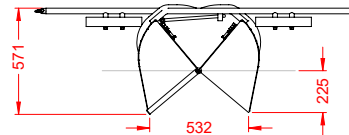
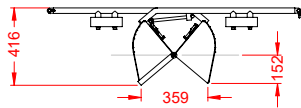
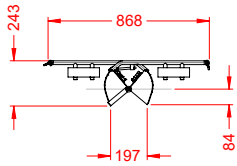
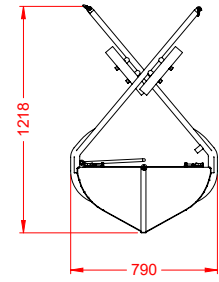
0.025 m²0.1 m²0.2 m²0.25 m²

Sample size : 0.141m x 0.197m = 0.02777 m²
 Bare weight : 7.5 kg
 Ballast weight : 4.5 kg per weight up to 4 weights

Sample size : 0.281m x 0.359m = 0.100879 m²
 Bare weight : 24 kg
 Ballast weight : 4.5 kg per weight up to 4 weights

Sample size : 0.376m x 0.532m = 0.200032 m²
 Bare weight : 39 kg
 Ballast weight : 8kg per weight up to 4 weights

Sample size : 0.471 m x 0.531 m = 0.2501 m²
 Bare weight : 45 kg
 Ballast weight : 8kg per weight up to 4 weights

Further Information

Feritech's continuously expanding geotechnical equipment line offers impressive value-adding extras not found anywhere else. Add in global delivery, outstanding technical support, fast consumables supply and exceptional reliability and you have a winning formula for your geotechnical equipment and consumable supply needs. All our products have been designed, manufactured and tested by a team that truly understand the geotechnical offshore market. With total turnkey system solutions on offer you can rely on Feritech to provide the coring hardware, winch, cabling, spares and consumables you need, on time and within your budget.

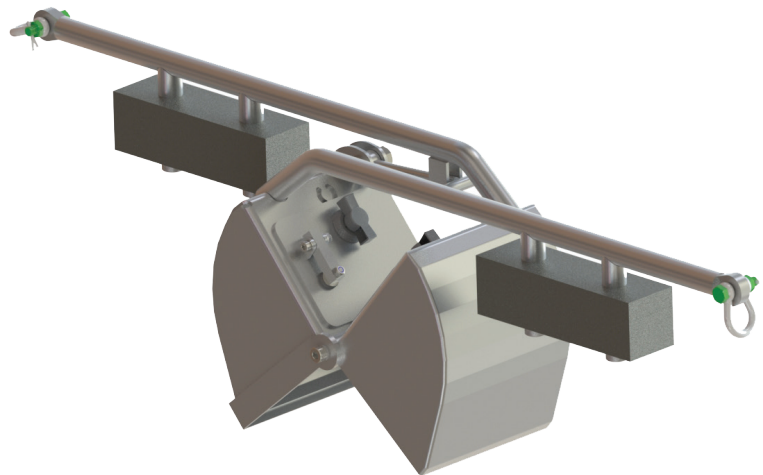

FT560 VAN VEEN GRAB SPECIFICATION

Model	Length	Width	Height	Overall Weight (excluding ballast)
0.025m ²	868mm	297mm	560mm	7.5kg
0.1m ²	1365mm	526mm	920mm	2.4kg
0.2m ²	1709mm	790mm	1218mm	39kg
0.25m ²	1709mm	790mm	1218mm	45kg